

**TECHNICAL SPECIFICATION**

**COLOURS**

**COUNTER TOP - GLASS**



WHITE, TEMPERED  
GLASS

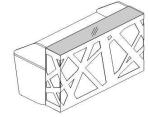

**BODY**

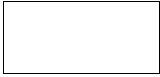

67 WHITE PASTEL

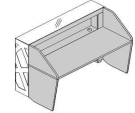
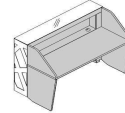

**FRONT - METAL**



15 HIGH GLOSS  
WHITE

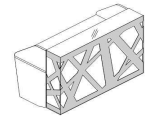

**FRONT - PLEXIGLASS**



PLEXIGLASS  
WHITE



TECHNICAL SPECIFICATION

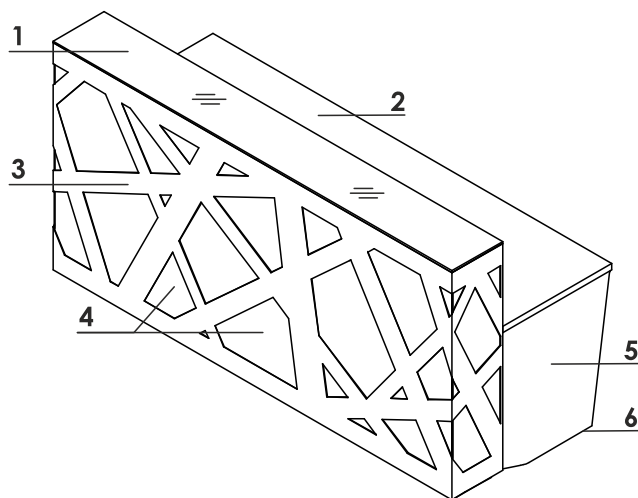

- 1. **Top** - tempered optiwhite glass, 8mm - painted on bottom side
- 2. **Work top** - MFC 28mm, PVC edge
- 3. **Front** - powder coated steel and plexiglas
- 4. **Light source** - RGBW LED, remote control
- 5. **Low side panel** - MFC 28mm, PVC edge
- 6. **Leveling** - 5mm range

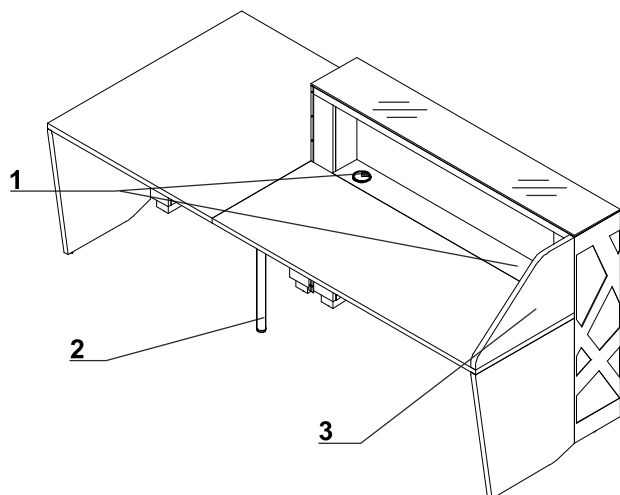

- 1. **Cable grommets** - Ø80
- 2. **Supporting leg NE41**- required for connecting the tops
- 3. **Vertical panel** - MFC 28mm, PVC edge

DIMENSIONS

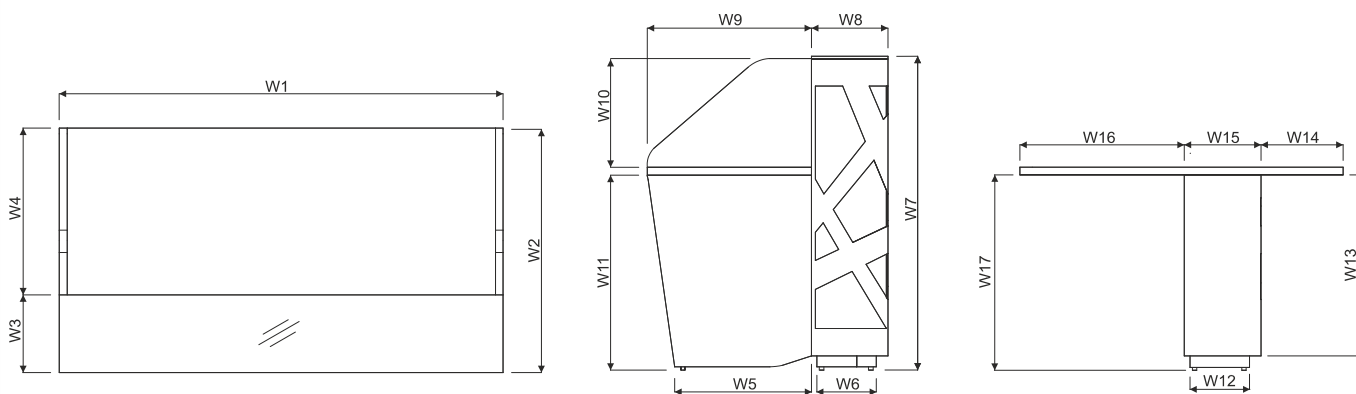

W1 - 1600mm | W2 - 880mm | W3 - 280mm | W4 - 600mm | W5 - 500mm | W6 - 217mm | W7 - 1146mm | W8 - 280mm | W9 - 600mm | W10 - 397mm | W11 - 712mm | W12 - 217mm | W13 - 660mm | W14 - 300mm | W15 - 280mm | W16 - 600mm | W17 - 712mm

RECEPTION DESKS SYSTEMS

LZN51+LZG22+LZB22+LZG22+LZB22M

INDEX SYMBOL	DIMENSIONS [mm]									COMMENTS
	W <sub>1</sub>	W <sub>2</sub>	D <sub>1</sub>	D <sub>2</sub>	H		kg	m <sup>3</sup>	pcs	
<b>LZG44</b>	2480	2200	-	-	1146		278.2	3.233	18	

LZK01+LZN51+LZG22+LZB22+LZG22+LZB22M

INDEX SYMBOL	DIMENSIONS [mm]									COMMENTS
	W <sub>1</sub>	W <sub>2</sub>	D <sub>1</sub>	D <sub>2</sub>	H		kg	m <sup>3</sup>	pcs	
<b>LZG45</b>	2480	2200	-	-	1146		285.2	3.252	19	

<sup>16</sup> <sup>16</sup>  
LZK01+LZN51+LZG22+LZB22

INDEX SYMBOL	DIMENSIONS [mm]									COMMENTS
	W <sub>1</sub>	W <sub>2</sub>	D <sub>1</sub>	D <sub>2</sub>	H		kg	m <sup>3</sup>	pcs	
<b>LZG34</b>	1600	880	-	-	1146		127.9	1.250	9	
<b>LZG46</b>	2200	880	-	-	1146		157.9	1.694	10	

DESCRIPTION

NET WEIGHT

VOLUME

NUMBER OF PACKAGES

RECEPTION DESKS SYSTEMS

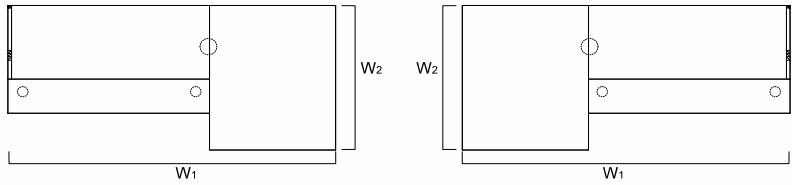
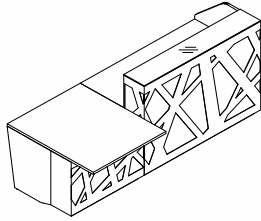

LZN51+LZG10+NE41+LZG22+LZB22+LZK01<sup>16</sup><sup>16</sup>

INDEX SYMBOL	DIMENSIONS [mm]									COMMENTS
	W <sub>1</sub>	W <sub>2</sub>	D <sub>1</sub>	D <sub>2</sub>	H		kg	m <sup>3</sup>	pcs	
<b>LZG50</b>	2600	1180	-	-	1146		210.4	1.822	15	
<b>LZG51</b>	3200	1180	-	-	1146		238.9	2.249	15	

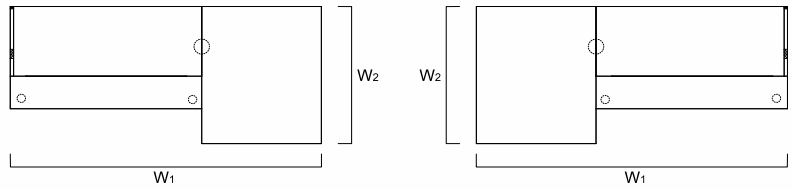
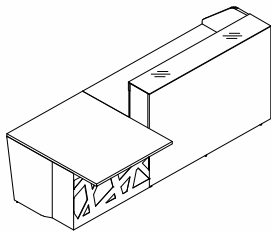

LZB16+LZG16M+LZG10+LZN51+LZK01+NE41

INDEX SYMBOL	DIMENSIONS [mm]									COMMENTS
	W <sub>1</sub>	W <sub>2</sub>	D <sub>1</sub>	D <sub>2</sub>	H		kg	m <sup>3</sup>	pcs	
<b>LZG56</b>	2600	1180	-	-	1146		212.4	1.822	15	

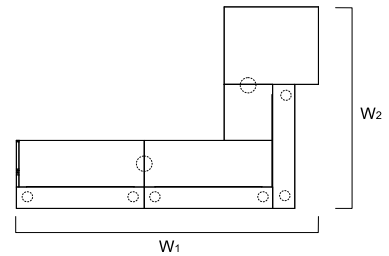
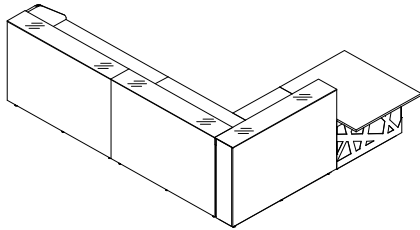

3xLZG16M+LZG10+LZK01+LZN51+LZB16M+2xLZB16+2xNE41

INDEX SYMBOL	DIMENSIONS [mm]									COMMENTS
	W <sub>1</sub>	W <sub>2</sub>	D <sub>1</sub>	D <sub>2</sub>	H		kg	m <sup>3</sup>	pcs	
<b>LZG57</b>	3200	2880	-	-	1146		423.2	4.215	31	

DESCRIPTION

NET WEIGHT

VOLUME

NUMBER OF PACKAGES

RECEPTION DESKS SYSTEMS

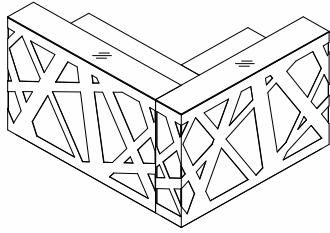

LZN51+LZG16+LZB16+LZG16+LZB16M

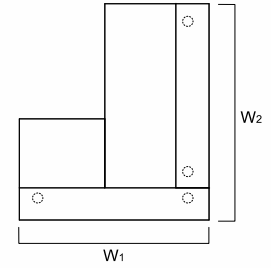
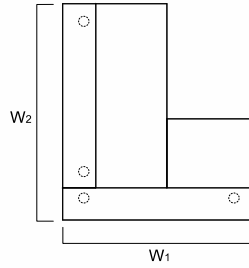

INDEX SYMBOL	DIMENSIONS					[mm]	⚖️	📦	📦		COMMENTS
	W <sub>1</sub>	W <sub>2</sub>	D <sub>1</sub>	D <sub>2</sub>	H						
<b>LZG32</b>	1600	1880	-	-	1146		219.5	2.395	16		

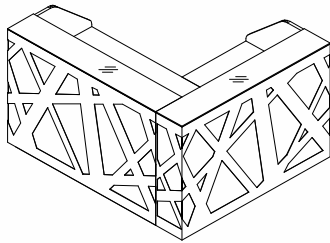

LZK01+LZN51+LZG16+LZB16+LZG16+LZB16M

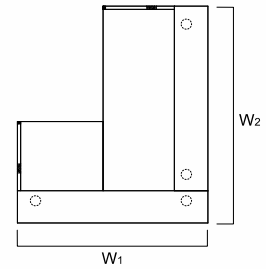
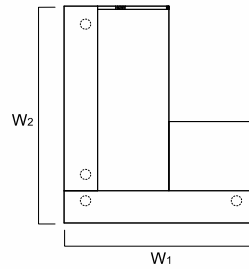

INDEX SYMBOL	DIMENSIONS					[mm]	⚖️	📦	📦		COMMENTS
	W <sub>1</sub>	W <sub>2</sub>	D <sub>1</sub>	D <sub>2</sub>	H						
<b>LZG35</b>	1600	1880	-	-	1146		226.5	2.414	17		

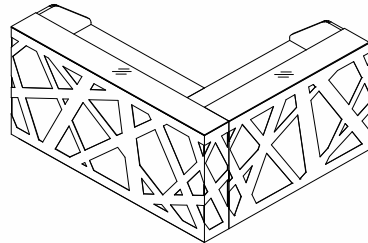

LZK01+LZN51+LZG22+LZB22M+LZG16+LZB16

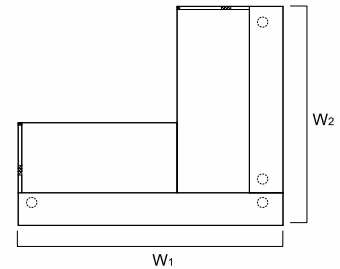
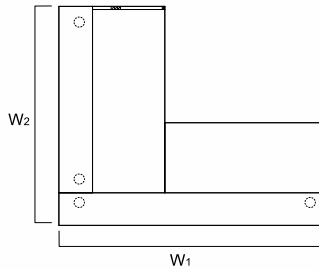

INDEX SYMBOL	DIMENSIONS					[mm]	⚖️	📦	📦		COMMENTS
	W <sub>1</sub>	W <sub>2</sub>	D <sub>1</sub>	D <sub>2</sub>	H						
<b>LZG36</b>	2200	1880	-	-	1146		254.5	2.807	17		

DESCRIPTION

⚖️ NET WEIGHT

📦 VOLUME

📦 NUMBER OF PACKAGES

RECEPTION DESKS SYSTEMS

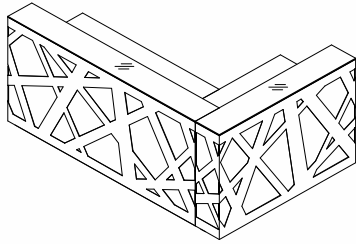

LZN51+LZG22+LZB16+LZG16+LZB22M

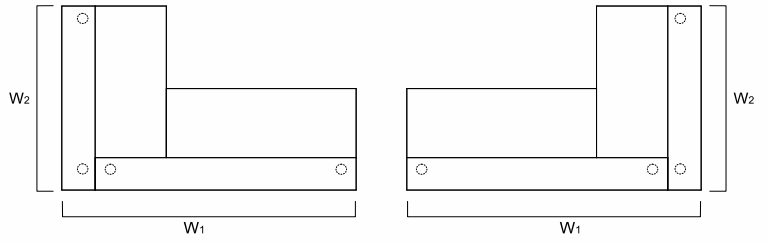

INDEX SYMBOL	DIMENSIONS [mm]										COMMENTS
	W <sub>1</sub>	W <sub>2</sub>	D <sub>1</sub>	D <sub>2</sub>	H						
<b>LZG38</b>	2480	1600	-	-	1146		247.5	2.788	16		

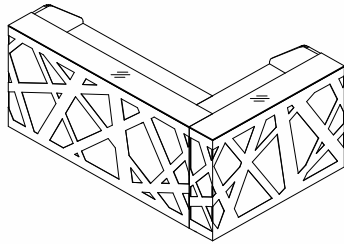

LZK01+LZN51+LZG22+LZB16+LZG16+LZB22M

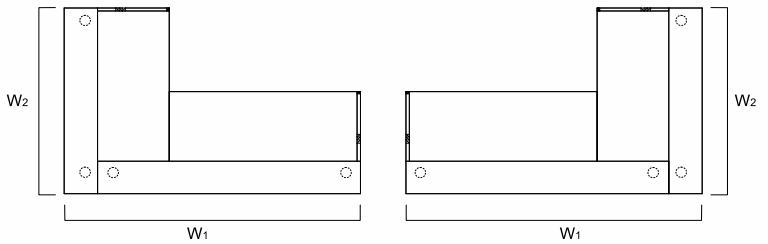

INDEX SYMBOL	DIMENSIONS [mm]										COMMENTS
	W <sub>1</sub>	W <sub>2</sub>	D <sub>1</sub>	D <sub>2</sub>	H						
<b>LZG40</b>	2480	1600	-	-	1146		254.5	2.807	17		

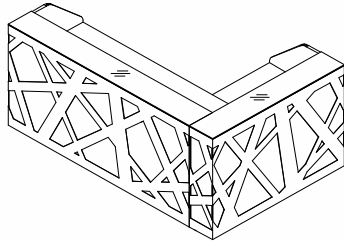

LZK01+LZN51+LZG22+LZB22+LZG16+LZB16M

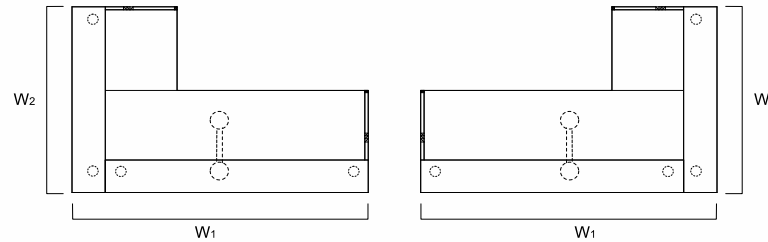

INDEX SYMBOL	DIMENSIONS [mm]										COMMENTS
	W <sub>1</sub>	W <sub>2</sub>	D <sub>1</sub>	D <sub>2</sub>	H						
<b>LZG42</b>	2480	1600	-	-	1146		254.4	2.857	15		

DESCRIPTION

NET WEIGHT

VOLUME

NUMBER OF PACKAGES

RECEPTION DESKS SYSTEMS

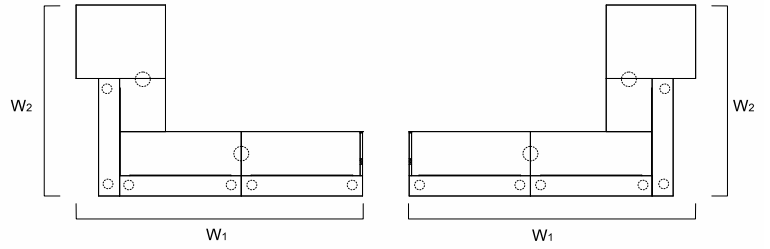
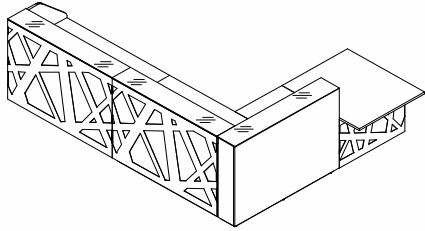

LZG16M+2xLZG16+LZG10+LZK01+LZN51+LZB16M+2xLZB16+2xNE41

INDEX SYMBOL	DIMENSIONS					[mm]	⚖️	📦	📦		COMMENTS
	W <sub>1</sub>	W <sub>2</sub>	D <sub>1</sub>	D <sub>2</sub>	H						
<b>LZG58</b>	3808	2880	-	-	1146		419.2	4.215	31		

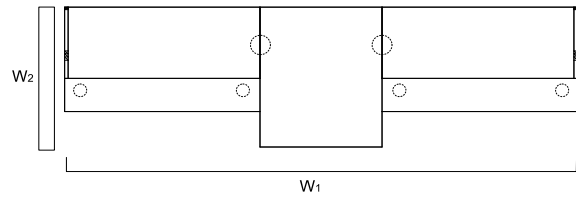
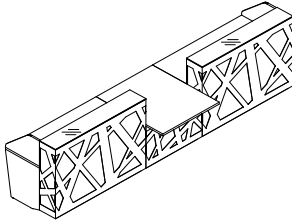

<sup>16</sup><sub>16</sub> LZN51+<sup>16</sup><sub>16</sub> LZG22+<sup>16</sup><sub>16</sub> LZB22+NE41+LZG10+NE41+<sup>16</sup><sub>22</sub> LZG22+<sup>16</sup><sub>22</sub> LZB22+LZK01

INDEX SYMBOL	DIMENSIONS					[mm]	⚖️	📦	📦		COMMENTS
	W <sub>1</sub>	W <sub>2</sub>	D <sub>1</sub>	D <sub>2</sub>	H						
<b>LZG52</b>	4200	1180	-	-	1146		317.8	3.034	23		
<b>LZG53</b>	4800	1180	-	-	1146		347.8	3.479	24		
<b>LZG54</b>	5400	1180	-	-	1146		377.8	3.923	25		

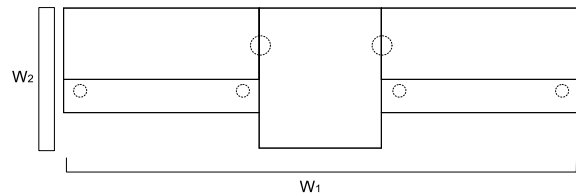
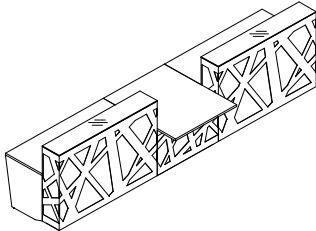

LZN51+LZG16+LZB16+NE41+LZG10+NE41+LZG16+LZB16

INDEX SYMBOL	DIMENSIONS					[mm]	⚖️	📦	📦		COMMENTS
	W <sub>1</sub>	W <sub>2</sub>	D <sub>1</sub>	D <sub>2</sub>	H						
<b>LZG55</b>	4200	1180	-	-	1146		310.8	3.015	22		

DESCRIPTION

⚖️ NET WEIGHT

📦 VOLUME

📦 NUMBER OF PACKAGES

RECEPTION DESKS SYSTEMS

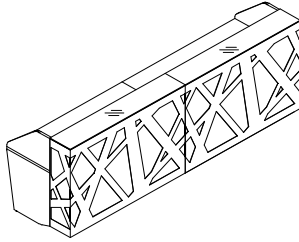

LZK01+LZN51+LZG22+LZB22+NE41+LZG22+LZB22  
 16 16 16 16  
 16 22 22 22

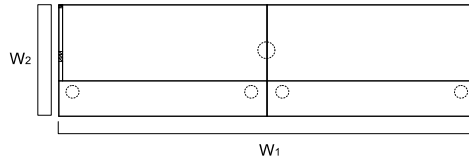

INDEX SYMBOL	DIMENSIONS [mm]						⚖️	📦	📦		COMMENTS
	W <sub>1</sub>	W <sub>2</sub>	D <sub>1</sub>	D <sub>2</sub>	H						
LZG60	3200	880	-	-	1146		235.3	2.462	17		
LZG61	3800	880	-	-	1146		265.3	2.906	18		
LZG62	4400	880	-	-	1146		295.3	3.351	19		

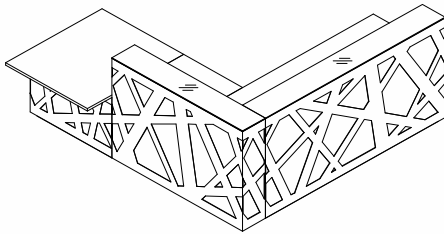

LZN51+LZG10+NE41+LZG16+LZB16M+LZG22+LZB22

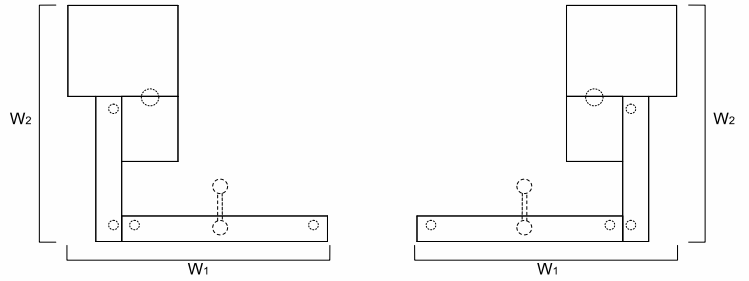

INDEX SYMBOL	DIMENSIONS [mm]						⚖️	📦	📦		COMMENTS
	W <sub>1</sub>	W <sub>2</sub>	D <sub>1</sub>	D <sub>2</sub>	H						
LZG64	2600	2780	-	-	1146		331.3	3.411	22		

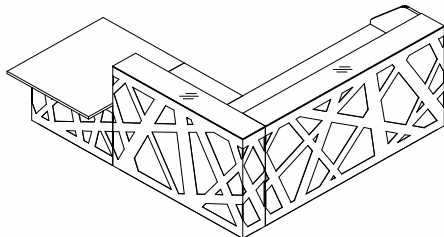

LZN51+LZG10+NE41+LZG16+LZB16M+LZG22+LZB22+LZK01

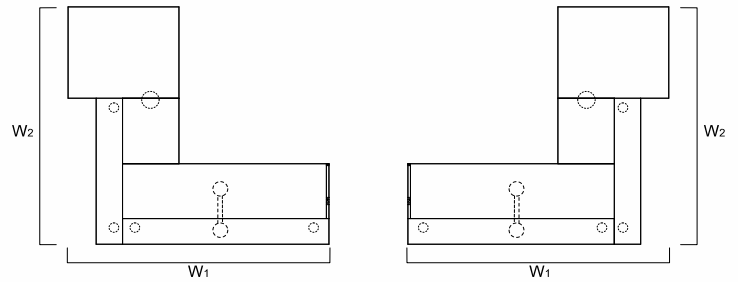

INDEX SYMBOL	DIMENSIONS [mm]						⚖️	📦	📦		COMMENTS
	W <sub>1</sub>	W <sub>2</sub>	D <sub>1</sub>	D <sub>2</sub>	H						
LZG63	2600	2780	-	-	1146		338.3	3.431	23		

DESCRIPTION

⚖️ NET WEIGHT

📦 VOLUME

📦 NUMBER OF PACKAGES



PRODUCT ILLUSTRATION	DIMENSIONS [mm]			INDEX SYMBOL						COMMENTS
	WIDTH	DEPTH	HEIGHT			kg	m3	pcs		

**COMPOSITION ELEMENTS**

	1600	280	1146	<b>LZG16M</b>		89.5	1.147	4		
	1600	280	1146	<b>LZG16</b>		87.5	1.147	4		
	2200	280	1146	<b>LZG22</b>		108.5	1.527	4		
	1000	1180	740	<b>LZG10</b>		81.0	0.555	5		
	720	600	28	<b>LZB16M</b>		10.4	0.017	3		
	1320	600	28	<b>LZB22M</b>		18.1	0.031	4		
	1600	600	28	<b>LZB16</b>		18.4	0.049	3		
	2200	600	28	<b>LZB22</b>		25.4	0.050	3		use of support leg NL41 in the middle of worktop advisable!
	600	28	397	<b>LZK01</b>		7.0	0.020	1		
	600	28	712	<b>LZN51</b>		15.0	0.035	1		
	40	40	712	<b>NE41</b>		1.5	0.017	1		round profile leg

DESCRIPTION

NET WEIGHT

VOLUME

NUMBER OF PACKAGES

PRODUCT ILLUSTRATION	DIMENSIONS [mm]			INDEX SYMBOL						COMMENTS
	WIDTH	DEPTH	HEIGHT			kg	m3	pcs		

**COMPOSITION ELEMENTS**

	460	110	121	<b>E64</b>		0.0	0.000	0		horizontal cable tray 09-aluminum
	580	162	123	<b>S69</b>		1.0	0.015	1		09 - aluminum